

UNA 27 h, DN 25, Duplex

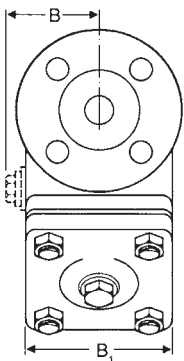

Hand vent valve

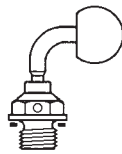

Float lifting lever

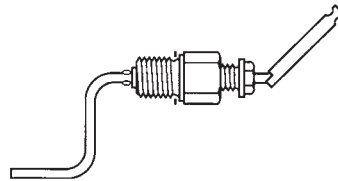

Dimensions and Weights				
Nominal sizes	[mm]	25	40	50
DN	[in]	1	1½	2
Overall length in mm	L			
Flanged DIN PN 63		300	420	416
Flanged ASME 300 RF		287	405	408
Flanged ASME 400/600 RF		300	421	427
Butt-weld ends DIN 3239		300	420	420
Socket-weld ends DIN 3239		300	420	420
Dimensions in mm	H	198	330	330
	H <sub>1</sub>	80	90	90
	B	80	111	111
	B <sub>1</sub>	80	225	225
	Flange dimensions DIN 2546	D	140	170
b		24	28	26
k		100	125	135
g		68	88	102
l		18	22	22
Number of bolts		4	4	4
Approx. weight	[kg]	20	54	55

Materials		
	DIN reference	ASTM equivalent <sup>1)</sup>
Body	G20Mo5 (6522Mo4) (1.5419)	A217 WC 1
Gaskets	Graphite//CrNi	
Cover screws	21 CrMoV 57 (1.7709)	A193 B 16
Nuts	24 CrMo 5 (1.7258)	A193 B 16
Seat	X8CrNiS 18 9 X80CrSiMoW 15 2 (1.4305 / 1.4732)	(AISI 303/ Stellite)
Ball valve	X6CrNiMoTi 17122 (1.4571)	A182 F 304
Ball float	X6CrNiMoTi 17122 (1.4571)	A182 F 316
Bellows	X6CrNiTi 18 10 (1.4541)	A182 F 321
Others internals	X5CrNi 18 10 (1.4301)	A182 F 304

<sup>1)</sup> Physical and chemical properties comply with DIN grade ASTM nearest equivalent stated for guidance only.

## Float Trap UNA 27 h PN 63, DN 25, 40, 50 mm (1", 1½", 2")

### Description

Ball float trap with rolling ball valve and Duplex control (thermostatic bellows for automatic air venting) for draining large condensate flowrates from steam systems. With non-return valve and drain plug.

With Simplex control (without bellows) and hand vent valve for the discharge of cold condensates or distillates and for draining superheated steam, gas or compressed-air lines.

Body with bolted cover. Control unit easily replaced without removing trap from the line.

### On request:

- with float-lifting lever
- Hand vent valve (for Duplex design)

### Pressure / Temperature Rating

PMA (Maximum allowable pressure)	[bar g]	63	56	47	45
	[psi g]	915	810	680	650
TMA (Maximum allowable temperature)	[°C]	250	300	400	450
	[°F]	482	572	752	842
ΔPMX (Maximum differential pressure (inlet pressure minus outlet pressure))		45 bar (650 psi) (28 or 16 bar)			

### Connections

- Flanges: DIN 2546 (form E) PN 63
- Flanges ASME B 16.5 Cl. 300, 400/600
- Socket-weld ends DIN 3239 Class 3000
- Butt-weld ends DIN 3239

### Butt-weld ends according to DIN 3239-2-R3, edge form 22 according to DIN 2559

DN				
mm	in	Ø d <sub>2</sub>	Ø d <sub>1</sub>	for pipe
25	1	34	28.5	33.7 x 2.6
40	1½	49	43	48.3 x 2.6
50	2	61	54	60.3 x 3.2

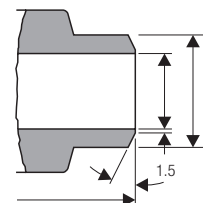

### Socket-weld ends acc. to DIN 3239-R5 / ASME B 16.11, Class 3000

DN				
mm	in	□ D <sub>2</sub>	□ D <sub>1</sub>	b
25	1	46	34.1	13
40	1½	65	48.7	13
50	2	76	61.5	13

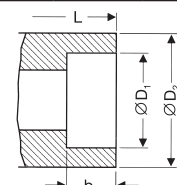

Float Trap  
**UNA 27 h**  
**PN 63, DN 25, 40, 50 mm**  
**(1", 1½", 2")**

**Capacity Chart**

The chart shows the maximum capacities of hot condensate for the range of orifices (O) and sizes available. The cold water capacities are: Capacity of hot condensate multiplied by factor F.

The capacities are dependent on the differential pressure (working pressure). The differential pressure is the difference between inlet and outlet pressures and depends among other things on the run of the line. If the condensate downstream of the trap is lifted, the differential pressure (working pressure) is reduced by approximately 1 bar for 7 m (or 2 psi for 3 feet) in lift.

The maximum admissible differential pressure is dependent on the cross-sectional area of the orifice.

The standard design of the trap is available for a maximum differential pressure of 45 bar (650 psi), see thick lines in the chart.

If, however, larger capacities are required, special orifices are available for differential pressures of: 28 bar (405 psi) or 16 bar (230 psi) (dashed lines in the chart).

Orifice (O)	DN 25	
	k <sub>vs</sub> values [m³/h]	Ø of hole [mm]
0 45	0.31	3
0 28	0.38	3.5
0 16	0.44	4.1
DN 40 + 50		
0 45	1.1	6.5
0 28	1.5	7
0 16	2.1	8.5

**When ordering please state:**

Inlet pressure, outlet pressure, quantity of condensate to be discharged, design, size and desired orifice, position of the trap and details of application.

The following test certificates can be issued on request, at extra cost:

In accordance with EN 10204-2.1, -2.2, -3.1A, -3.1B and -3.1C.

All inspection requirements have to be stated with the order. After supply of the equipment certification cannot be established. For tests and inspection charges please consult us.

Supply in accordance with our general terms of business.

**Capacity Chart**

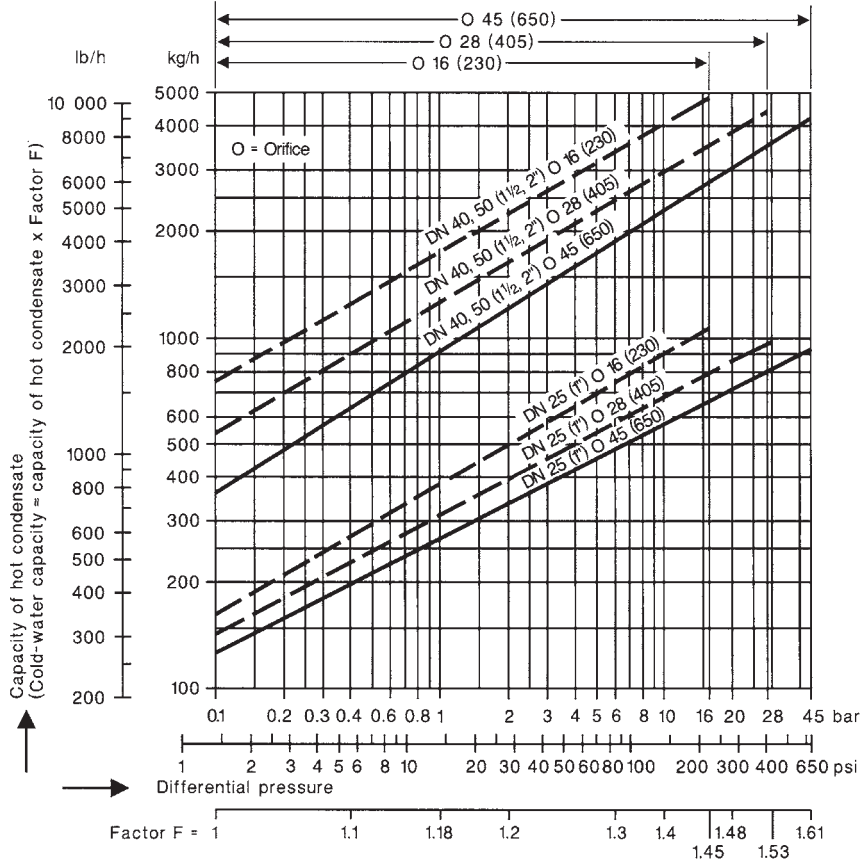

**Spare Parts**

Item No.	Designation	Order No.			
		DN 25 mm	DN 40, 50 mm		
<b>K</b>	Seat including gasket <b>J</b>	0 45	560 382	560 385	
		0 28	560 383	560 386	
		0 16	560 384	560 387	
<b>O</b>	Cover gasket (DN 25: 88 x 106 x 1, DN 40, 50: 152 x 172 x 1)		522 247	522 248	
<b>L</b>	Control unit Duplex with cover gasket and 2 socket-head screws, <b>without seat</b>	<b>O</b>	560 367	560 369	
	Control unit Simplex with cover gasket and 2 socket-head screws, <b>without seat</b>	<b>O</b>	560 366	560 368	
	Control unit Duplex with seat gasket , cover gasket <b>O</b> , 2 socket-head screws, <b>and seat</b>	<b>J</b>	0 45	560 378	560 381
		<b>O</b>	0 28	560 377	560 380
		<b>O</b>	0 16	560 376	560 379
Control unit Simplex with seat gasket , cover gasket <b>O</b> , 2 socket-head screws, <b>and seat</b>	<b>J</b>	0 45	560 372	560 375	
	<b>O</b>	0 28	560 371	560 374	
	<b>O</b>	0 16	560 370	560 373	

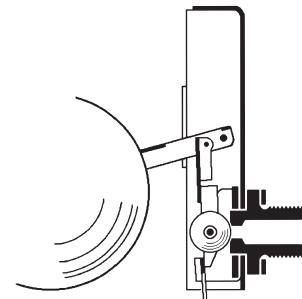
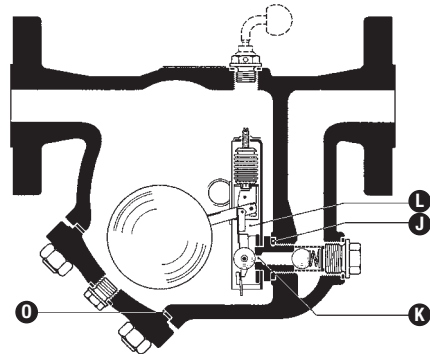

Control unit Simplex

**GESTRA AG**

Münchener Straße 77, 28215 Bremen, Germany  
 Telefon +49 421 3503-0, Telefax +49 421 3503-393  
 E-mail info@de.gestra.com, Web www.gestra.de

**GESTRA**

**Distributor : Energy Technology Co., Ltd.**

Tel.: +66 2 721 3860 - Fax.: +66 2 721 3869 - E-mail: sales@energytechnology.co.th - http:// www.energytechnology.co.th